



PIDG

TE Internal #: 2-36161-4

Ring Terminals & Spade Terminals, Ring Tongue, 10 AWG Wire Size, 6.11 mm² Wire Size, 12066 CMA Wire Size, Stud Size #10, PIDG

[View on TE.com >](#)

Terminals & Splices > Ring Terminals & Spade Terminals > PIDG RING TONGUE TERMINALS

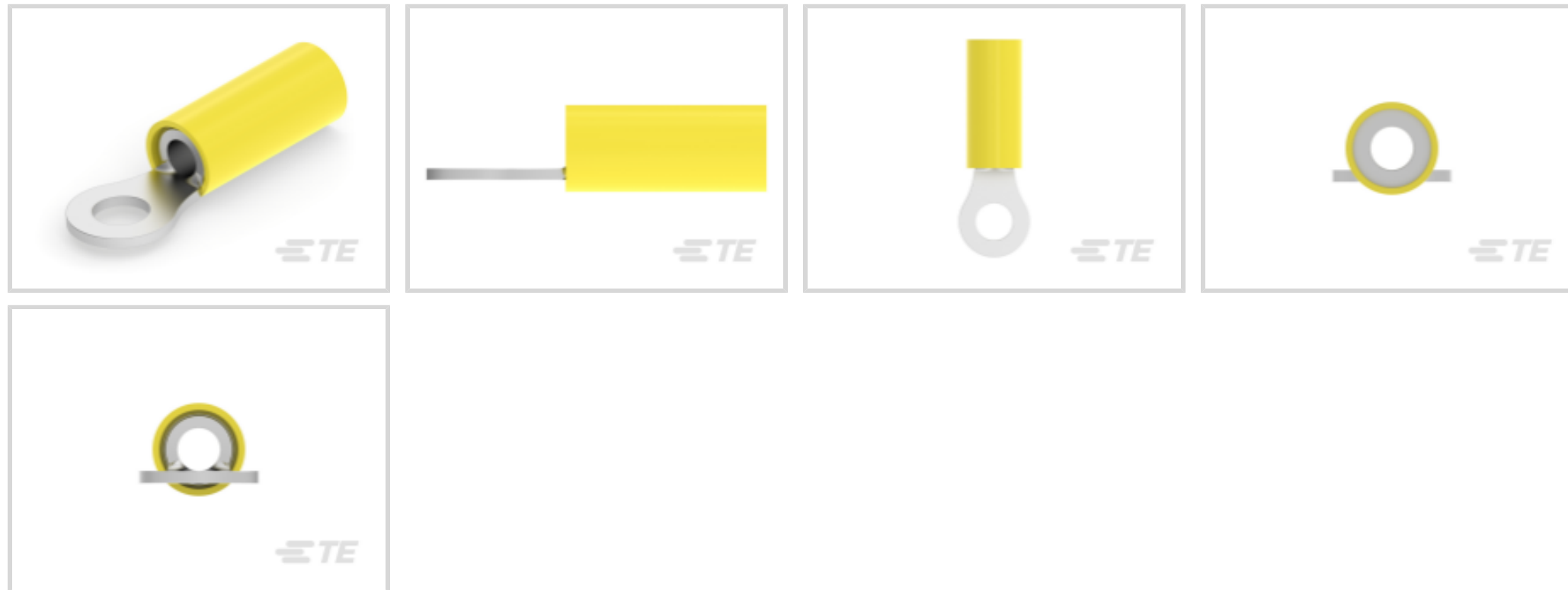

Ring & Spade Terminal Type: **Ring Tongue**

Wire Size: **12066 CMA**

Stud Size: **#10**

[All PIDG RING TONGUE TERMINALS \(421\)](#)

Features

Product Type Features

Shape Description	RING-042
Stud Size	#10
Sealable	No
Wire Insulation Support Retention Type	Insulation Restriction

Configuration Features

Number of Holes	1
Terminal Angle	180 °

Electrical Characteristics

Voltage (Max)	300 V
---------------	-------

Body Features

Inspection Slot	No
Weight per Piece	1.883 g
Stripe Color	Brown

Contact Features

--	--



Military Part Class	Class I
Ring & Spade Terminal Type	Ring Tongue
Barrel Type	Closed
Terminal Orientation	Offset
Terminal Plating Material	Tin

Mechanical Attachment

Wire Insulation Support	With
-------------------------	------

Dimensions

Wire Size	12066 CMA
Stud Diameter	5 mm[.197 in]
Tongue Thickness	.79 mm[.031 in]
Overall Product Length	29.16 mm[1.148 in]
Accepts Wire Insulation Diameter (Max)	5.08 mm[.2 in]
Accepts Wire Insulation Diameter Range	3.02 – 5.08 mm[.119 – .2 in]

Usage Conditions

Insulation Option	Partially Insulated
Operating Temperature Range	105 °C[221 °F]

Operation/Application

Compatible With Wire Base Material	Copper
Compatible With Wire Plating Material	Tin
Heavy Duty	No

Industry Standards

Government Qualified	Yes
----------------------	-----

Packaging Features

Packaging Quantity	500
Packaging Method	Loose Piece

Product Compliance

[For compliance documentation, visit the product page on TE.com>](#)

EU RoHS Directive 2011/65/EU	Compliant
EU ELV Directive 2000/53/EC	Compliant
China RoHS 2 Directive MIIT Order No 32, 2016	No Restricted Materials Above Threshold



EU REACH Regulation (EC) No. 1907/2006

Current ECHA Candidate List: JUNE 2022 (224)

Candidate List Declared Against: JAN 2021 (211)

Does not contain REACH SVHC

Halogen Content

Not Low Halogen - contains Br or Cl > 900 ppm.

Solder Process Capability

Not applicable for solder process capability

Product Compliance Disclaimer

This information is provided based on reasonable inquiry of our suppliers and represents our current actual knowledge based on the information they provided. This information is subject to change. The part numbers that TE has identified as EU RoHS compliant have a maximum concentration of 0.1% by weight in homogenous materials for lead, hexavalent chromium, mercury, PBB, PBDE, DBP, BBP, DEHP, DIBP, and 0.01% for cadmium, or qualify for an exemption to these limits as defined in the Annexes of Directive 2011/65/EU (RoHS2). Finished electrical and electronic equipment products will be CE marked as required by Directive 2011/65/EU. Components may not be CE marked. Additionally, the part numbers that TE has identified as EU ELV compliant have a maximum concentration of 0.1% by weight in homogenous materials for lead, hexavalent chromium, and mercury, and 0.01% for cadmium, or qualify for an exemption to these limits as defined in the Annexes of Directive 2000/53/EC (ELV). Regarding the REACH Regulation, the information TE provides on SVHC in articles for this part number is based on the latest European Chemicals Agency (ECHA) 'Guidance on requirements for substances in articles' posted at this URL: <https://echa.europa.eu/guidance-documents/guidance-on-reach>

Compatible Parts



TE Part # 59824-1
TETRA-CRIMP PIDG PG FASTON 22-10 ASSY



TE Part # 58433-3
PRO CR ASSY, RBY IS9252



TE Part # 59239-4
HHHT PIDG PG 12-10 ASSY



TE Part # 58423-1
DIE, RBY IS9252



TE Part # 2063030-1
SDE DIESET, RBY, UL



TE Part # 2217330-1
KIT, BTLI, 4 TON, NA



TE Part # 47808-6
DIES PIDG 12-10 DIE SET

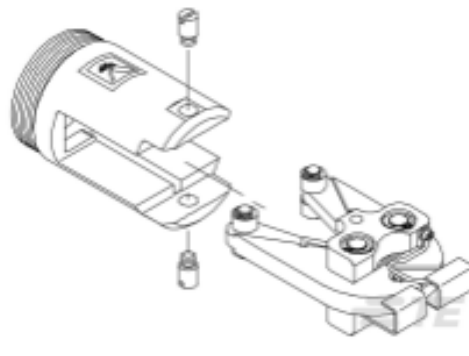

TE Part # 679300-1
1210 PIDG CRIMP HEAD



Also in the Series | PIDG

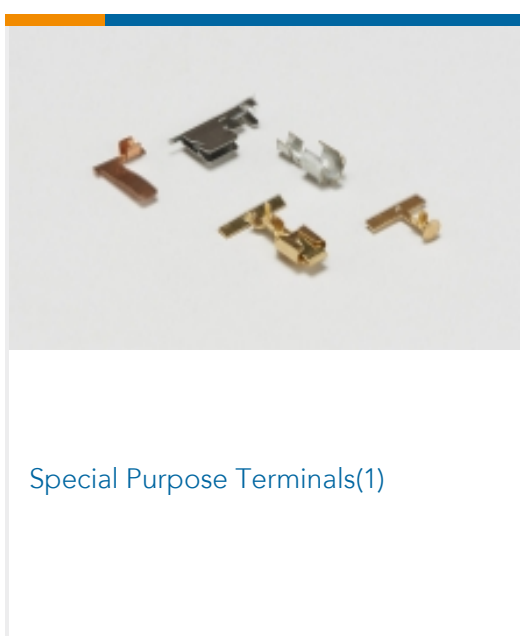
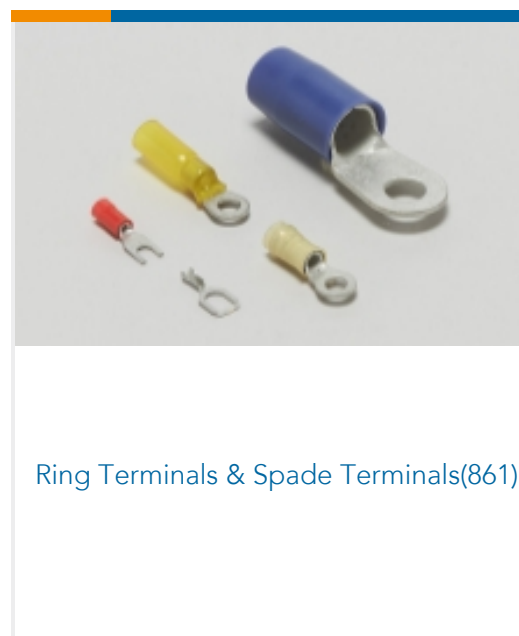
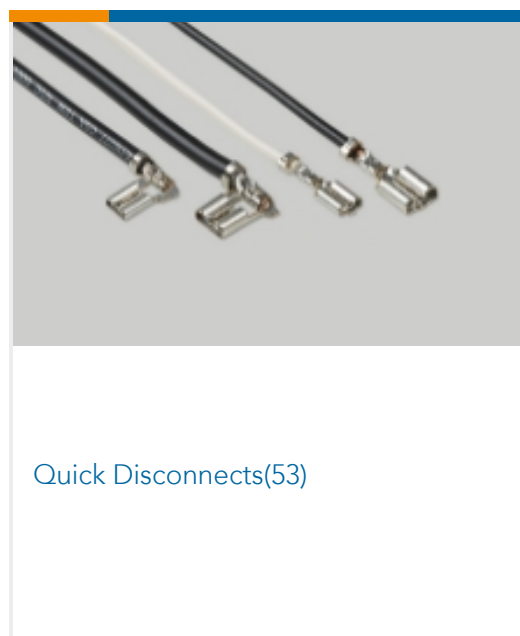
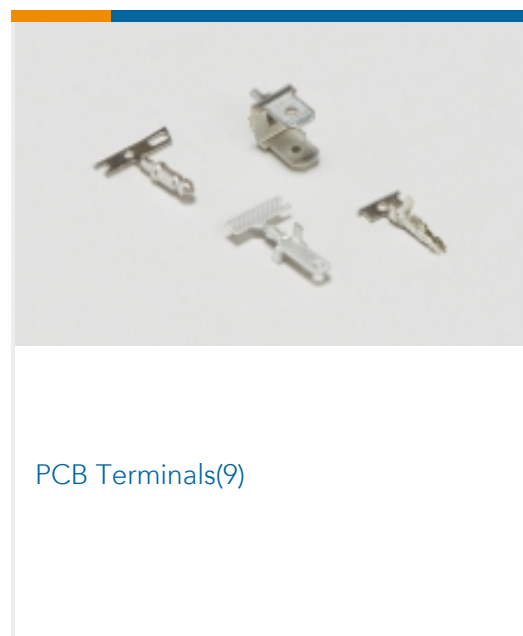
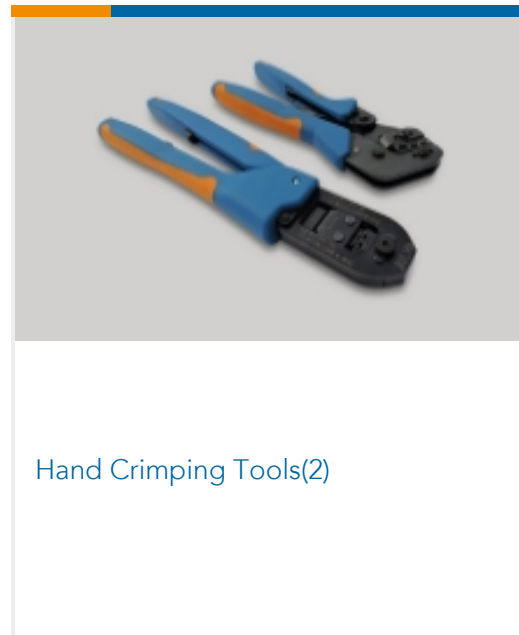
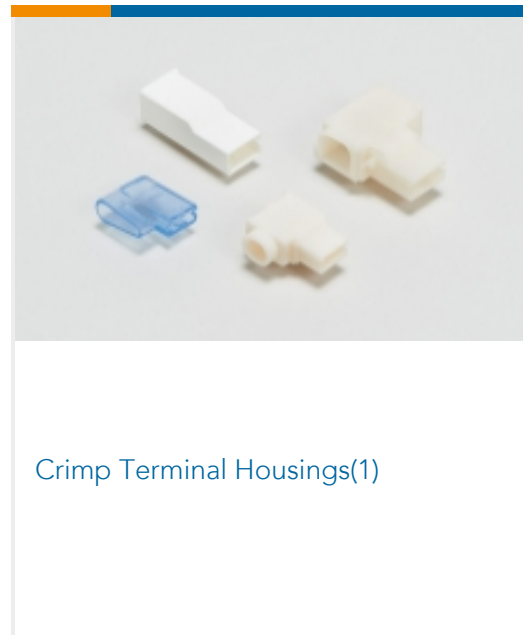
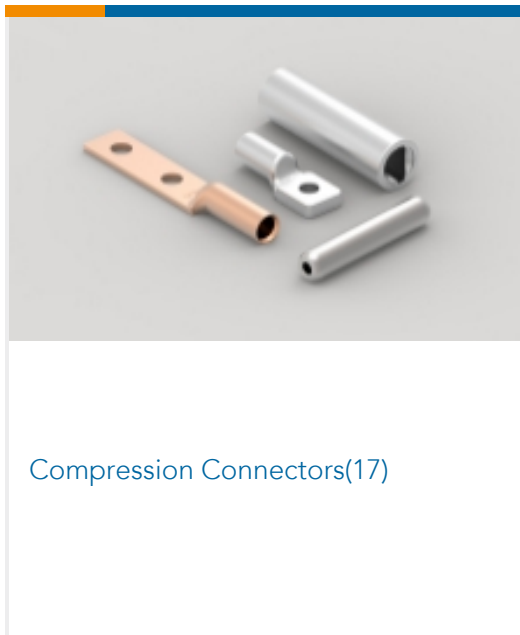

Documents

Product Drawings

TERMINAL,PIDG R IR 10 10

English

CAD Files

3D PDF

3D

Customer View Model



[ENG_CVM_CVM_2-36161-4_AK.2d_dxf.zip](#)

English

Customer View Model

[ENG_CVM_CVM_2-36161-4_AK.3d_igs.zip](#)

English

Customer View Model

[ENG_CVM_CVM_2-36161-4_AK.3d_stp.zip](#)

English

By downloading the CAD file I accept and agree to the [Terms and Conditions](#) of use.

Product Specifications

[Application Specification](#)

English

Product Environmental Compliance

[MD_2-36161-4_05022015519_dmtec](#)

English

[MD_2-36161-4_05022015519_dmtec](#)

English

Agency Approvals

[CSA Certificate](#)

English